



DAMON

Proiettore **IP67** orientabile a 230Vac, ideale per l'illuminazione di statue, alberi, portici, ingressi.

*Adjustable 230Vac **IP67** projector, ideal for the lighting of statues, trees, colonnades, entrances.*



DAMON S



DAMON M



DAMON L

DAMON M

DAMON



Materiale

Material

Corpo in alluminio anticorrosivo
Anticorrosive aluminium body

Staffa in acciaio inox satinato
Satinized stainless steel bracket

All versions **Vetro trasparente e lente in PMMA**
Transparent glass and PMMA lens

120° version **Vetro sabbizzato e lente in PMMA**
Sandblasted glass and PMMA lens

Pot. Assorbita

Abs. Power

S version **1 x 10W**

M version **1 x 20W**

L version **1 x 30W**

Collegamento

Connection

230Vac - Tensione di rete | Mains voltage

Cablaggio

Wiring

Fornito con 50 cm di cavo e X-Dry
Provided with 50 cm cable and X-Dry

Installazione

Installation

A terra, parete o soffitto con staffa (inclusa)
Floor, wall or ceiling mounting with brackets (included)

Floor, wall or ceiling mounting with brackets (included)

A terra con picchetto (non incluso)
On ground with peg (not included)

On ground with peg (not included)

Finitura

Finishing

.01 Alluminio anodizzato | Anodized aluminium

.02 Bianco opaco | Matt white RAL9003

.08 Nero opaco | Matt black RAL9005

.09 Corten

.17 Antracite | Anthracite

Disponibile su richiesta

Also available

5000 K

Lunghezza cavo su misura senza X-Dry p.511

Customized cable length without X-Dry p.511

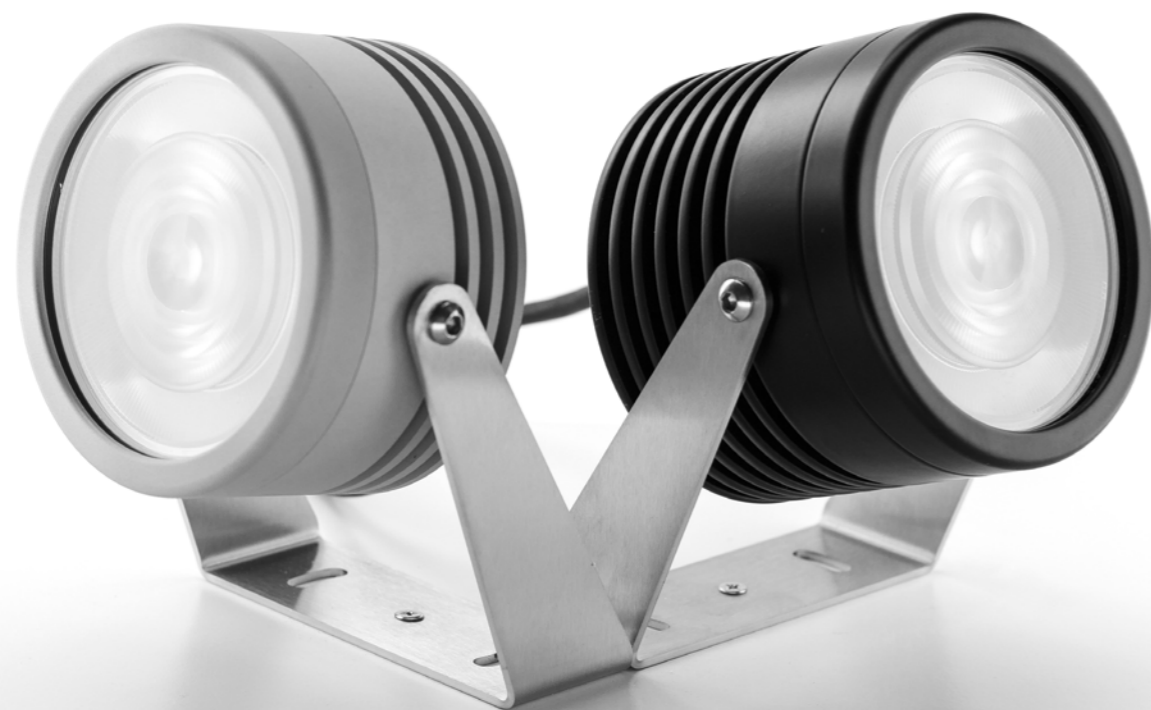

DAMON S

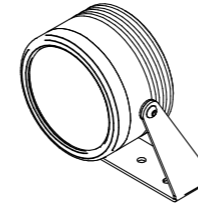

IP67 CE F E X D kg 1,4

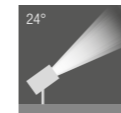
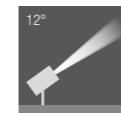

SUPPLY	W	LM	OPTICS	LED COLOR	CODE	+	FINISHING
230Vac	10	950	12°	3000 K	DAM11331	.	.01 .02 .08 .09 .17
230Vac	10	1000	12°	4000 K	DAM11341	.	.01 .02 .08 .09 .17
230Vac	10	950	24°	3000 K	DAM11332	.	.01 .02 .08 .09 .17
230Vac	10	1000	24°	4000 K	DAM11342	.	.01 .02 .08 .09 .17
230Vac	10	950	38°	3000 K	DAM11333	.	.01 .02 .08 .09 .17
230Vac	10	1000	38°	4000 K	DAM11343	.	.01 .02 .08 .09 .17
230Vac	10	950	120°	3000 K	DAM11334	.	.01 .02 .08 .09 .17
230Vac	10	1000	120°	4000 K	DAM11344	.	.01 .02 .08 .09 .17

Damon S Prodotto | Product

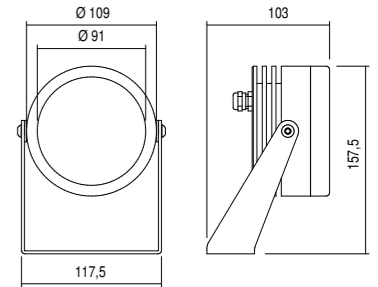

ACCESSORI | ACCESSORIES

Paralume | Shade

Code: PL005 Finishing: .02 .08 .09 .17

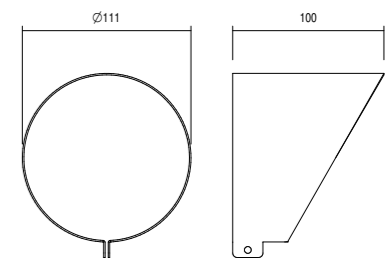

Picchetto | Peg Code: PI002

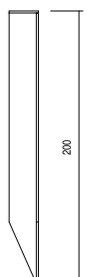

Dimmerazione non disponibile
Dimming not available

DAMON M

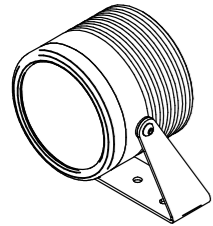

IP67 CE F E X D kg 1,85

	SUPPLY	W	LM	OPTICS	LED COLOR	CODE	+ FINISHING
	230Vac	20	1900	12°	3000 K	DAM12331	.01 .02 .08 .09 .17
	230Vac	20	2000	12°	4000 K	DAM12341	.01 .02 .08 .09 .17
	230Vac	20	1900	24°	3000 K	DAM12332	.01 .02 .08 .09 .17
	230Vac	20	2000	24°	4000 K	DAM12342	.01 .02 .08 .09 .17
	230Vac	20	1900	38°	3000 K	DAM12333	.01 .02 .08 .09 .17
	230Vac	20	2000	38°	4000 K	DAM12343	.01 .02 .08 .09 .17
	230Vac	20	1900	120°	3000 K	DAM12334	.01 .02 .08 .09 .17
	230Vac	20	2000	120°	4000 K	DAM12344	.01 .02 .08 .09 .17

Damon M Prodotto | Product

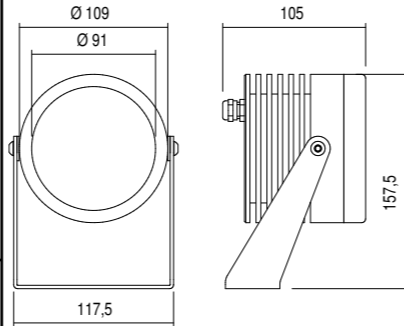

DAMON L

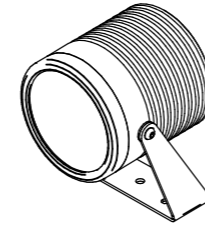

IP67 CE F E X D kg 2,29

	SUPPLY	W	LM	OPTICS	LED COLOR	CODE	+ FINISHING
	230Vac	30	2850	12°	3000 K	DAM13331	.01 .02 .08 .09 .17
	230Vac	30	3000	12°	4000 K	DAM13341	.01 .02 .08 .09 .17
	230Vac	30	2850	24°	3000 K	DAM13332	.01 .02 .08 .09 .17
	230Vac	30	3000	24°	4000 K	DAM13342	.01 .02 .08 .09 .17
	230Vac	30	2850	38°	3000 K	DAM13333	.01 .02 .08 .09 .17
	230Vac	30	3000	38°	4000 K	DAM13343	.01 .02 .08 .09 .17
	230Vac	30	2850	120°	3000 K	DAM13334	.01 .02 .08 .09 .17
	230Vac	30	3000	120°	4000 K	DAM13344	.01 .02 .08 .09 .17

Damon L Prodotto | Product

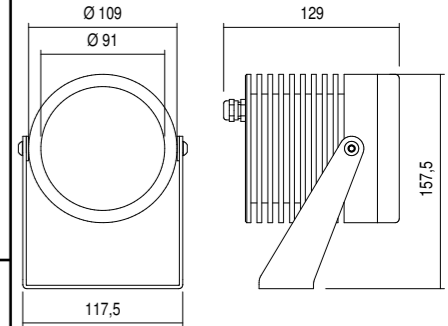

ACCESSORI | ACCESSORIES

Paralume | Shade

Code: PL005 Finishing: .01 .02 .08 .09 .17

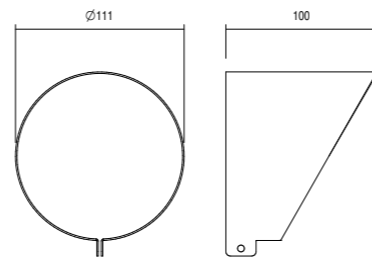

Picchetto | Peg Code: PI002



ACCESSORI | ACCESSORIES

Paralume | Shade

Code: PL005 Finishing: .01 .02 .08 .09 .17

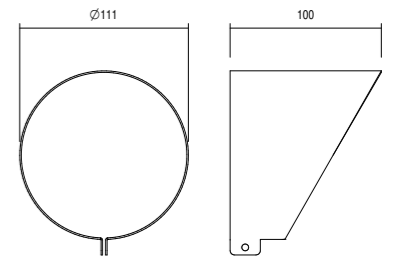

Picchetto | Peg Code: PI002

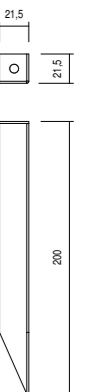

Dimmerazione non disponibile
Dimming not available

Dimmerazione non disponibile
Dimming not available